

ILLUMINA®



BS101LED ECO

- The **ILLUMINA® BS101LED ECO** is an economical, corrosion, flame and vandal resistant wet location luminaire.
- **HOUSING:** 100% UV stabilized polycarbonate, liquid silicone perimeter gasket with memory retention.
- **DIFFUSER:** The frosted UV stabilized polycarbonate diffuser eliminates glare and provides even light distribution.
- **LUMENS:** LO: 4744 - 5041 lm
HO: 7594 - 7919 lm
- **OPERATING TEMP:** HT (AC Only) -40°F to 104°F (-20°C to 40°C)
SA (AC & Emergency) 32°F to 104°F (0°C to 40°C)
- **POWER FACTOR:** >0.95
- **TOTAL HARMONICS DISTORTION (THD):** <20%
- **WEIGHT:** 9 lbs / 4.08 kg



APPLICATION: The **ILLUMINA® BS101LED ECO** provides ideal illumination for canopies, warehouses, schools, breezeways and service corridors. It can be installed both indoor & outdoor.

ORDERING INFORMATION

MODEL	LENGTH	OPERATION	OUTPUT	COLOR TEMP	INPUT	MOUNTING	OPTIONS	
BS101LED ECO	4 (ft)	HT (AC only)	LO ²	WT30 (3000K)	120-277V	blank (surface mount standard)	FA ⁴ (fully assembled)	NOD ⁶ (integrated node)
		SA ¹ (AC & EM)	HO	WT35 (3500K)	347-480V		FP (fuse protection - 3A)	SP (surge protection - 10KA)
				WT40 (4000K)		JM ³ (junction mount)	OS ^{5,6} (internal occ sensor)	SS (stainless steel clips)
				WT50 (5000K)				TPS (tamper proof screws)

CONTROLS & ACCESSORIES

1PKxWBS14 ^{7,8} (single pendant kit, white, x=length)	EMDCB ⁶ (wireless motion & lux sensor)	RLY ⁶ (Beghelli lighting control module relay)
1SPKxWBS14 ^{7,8} (swivel single pendant kit, white, x=length)	HHRFSIR ⁹ (handheld remote for FSP221)	SW1 ⁶ (single BT rocker wall switch)
2PKxW ^{7,8} (double stem pendant mount kit, white)	MLM1 ⁶ (wireless motion and lux sensor)	TPB (tamper proof driver bit)
2SPKxW ^{7,8} (swivel double stem pendant kit)	PM (pivot mount)	TM22BS14 ⁸ (22" trunnion mount bracket)
2ACx ⁹ (aircraft cable, x=length)	QMBWBS14 ¹⁰ (quick mount bracket)	
2CH48 ⁸ (48" chain hang kit, field cuttable)		

NOTE 1: Emergency pack 120-277V; 10W/1440 lm.

NOTE 2: No DLC for LO.

NOTE 3: JM direct j-box mount maintains fixture's IP66 rating

NOTE 4: Includes latches, grommets, etc. installed at the factory for quick installation

NOTE 5: OS is std Beghelli sensor (Magnum OSM1, CRMB9, OSFSP221, SBOR and other sensors also available)

NOTE 6: Beghelli offers wireless and powerless control solutions, contact factory for more details

NOTE 7: Standard pendant lengths "x" = 12 (12"), 24 (24") and 48 (48")

NOTE 8: Consult factory for non-standard lengths

NOTE 9: Handheld remote to adjust FSP221 occ sensor

NOTE 10: Quick Mount bracket requires JM mount; FA option recommended for maximum labor savings

TECHNICAL INFORMATION

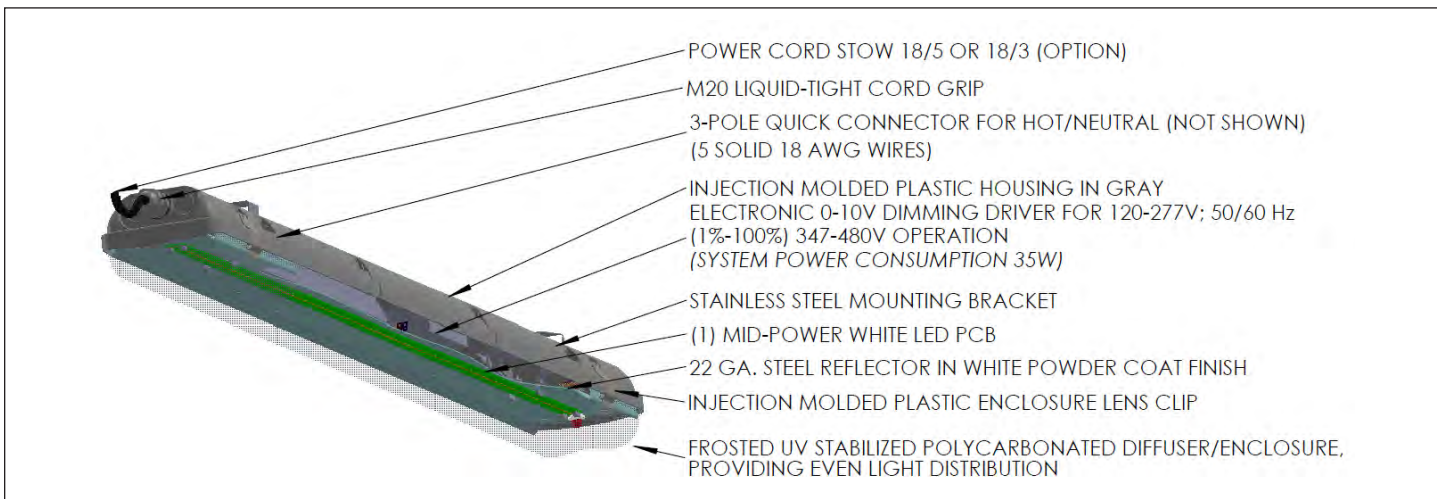

DIMENSIONS

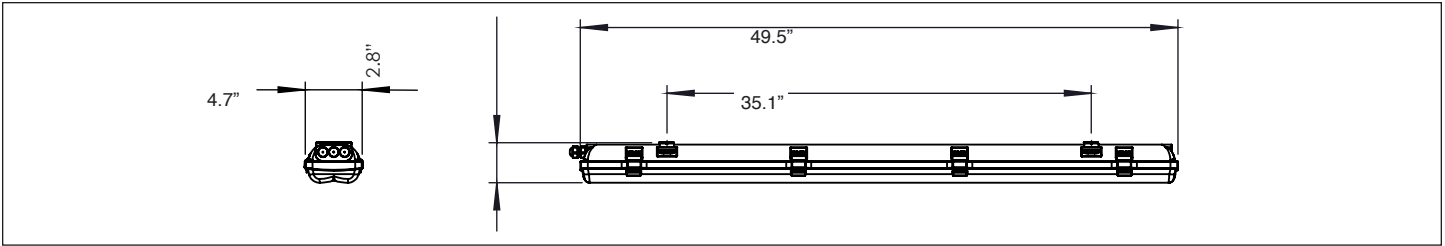

MOUNTING OPTIONS

Surface Mount (standard)

Aviation Cable Kit (2AC50, 2AC72)

Chain Hang Kit (2CH48)

Double Pendant Kit (2PK12W, 2PK24W, 2PK48W)

J-Box & Quick Mount Bracket Mount (JM, QMBWBS14)

Pivot Mount Kit PM

Single Pendant Kit (1PKxWBS04 x=12", 24", 48")

Swivel Double Pendant Kit (2SPK12W, 2SPK24W, 2SPK48W)

Swivel Single Pendant Kit (1SPKxWBS04, x=12", 24", 48")

Trunnion Mount Kit (TM22BS14)

NOTE: When wall mounted, DAMP LOCATION LISTED

PHOTOMETRICS

BS101LEDEC04HTLOWT40120-277V

POLAR CURVES

Characteristics
 Electronic driver
 LED 4000°K
 Lumens Per Lamp N.A. (absolute)
 Total Lamp Lumens N.A. (absolute)
 Luminaire Lumens 5458
 Total Luminaire Efficiency N.A.
 Luminaire Efficacy Rating (LER) 156
 Total Luminaire Watts 35
 Ballast Factor 1.00
 CIE Type Direct

ISOLINES

Zone	Lumens	%Lamp	%Fixt
0-20	686.27	N.A.	12.60
0-30	1406.48	N.A.	25.80
0-40	2263.97	N.A.	41.50
0-60	4021.64	N.A.	73.70
0-80	5151.08	N.A.	94.40
0-90	5334.73	N.A.	97.70
10-90	5149.34	N.A.	94.30
20-40	1577.7	N.A.	28.90
20-50	2482.9	N.A.	45.50
40-70	2446.65	N.A.	44.80
60-80	1129.43	N.A.	20.70
70-80	440.45	N.A.	8.10
80-90	183.65	N.A.	3.40
90-110	85.74	N.A.	1.60
90-120	107.31	N.A.	2.00
90-130	119.08	N.A.	2.20
90-150	123.70	N.A.	2.30
90-180	123.72	N.A.	2.30
110-180	37.98	N.A.	0.70
0-180	5458.45	N.A.	100.00

Total Luminaire Efficiency = N.A. %

BS101LEDEC04HTHOWT40120-277V

POLAR CURVES

Characteristics
 Electronic driver
 LED 4000°K
 Lumens Per Lamp N.A. (absolute)
 Total Lamp Lumens N.A. (absolute)
 Luminaire Lumens 8575
 Total Luminaire Efficiency N.A.
 Luminaire Efficacy Rating (LER) 156
 Total Luminaire Watts 55
 Ballast Factor 1.00
 CIE Type Direct

ISOLINES

Zone	Lumens	%Lamp	%Fixt
0-20	1075.68	N.A.	12.50
0-30	2208.91	N.A.	25.80
0-40	3567.23	N.A.	41.50
0-60	6312.73	N.A.	73.60
0-80	8092.13	N.A.	94.40
0-90	8382.21	N.A.	97.70
10-90	8091.23	N.A.	94.40
20-40	2481.55	N.A.	28.90
20-50	3899.57	N.A.	45.50
40-70	3840.22	N.A.	44.80
60-80	1779.4	N.A.	20.80
70-80	694.68	N.A.	8.10
80-90	290.08	N.A.	3.40
90-110	133.81	N.A.	1.60
90-120	167.09	N.A.	1.90
90-130	185.90	N.A.	2.20
90-150	193.13	N.A.	2.30
90-180	193.17	N.A.	2.30
110-180	59.36	N.A.	0.70
0-180	8575.38	N.A.	100.00

Total Luminaire Efficiency = N.A. %

ILLUMINA® BS101LED ECO

ADDITIONAL INFORMATION

ENERGY CHART

MODEL	LENGTH	EFFICACY	CONSUMPTION WATTAGE	LUMEN OUTPUT	CRI	L70 (HRS) TESTED	L70 (HRS) PROJECTED
BS101LED-ECO-4HT-LO-WT30-120-277V	4 ft	136 lm/W	35	4744	>80	>60,000	>100,000
BS101LED-ECO-4HT-LO-WT35-120-277V	4 ft	137 lm/W	35	4795	>80	>60,000	>100,000
BS101LED-ECO-4HT-LO-WT40-120-277V	4 ft	139 lm/W	35	4874	>80	>60,000	>100,000
BS101LED-ECO-4HT-LO-WT50-120-277V	4 ft	144 lm/W	35	5041	>80	>60,000	>100,000
BS101LED-ECO-4HT-HO-WT30-120-277V	4 ft	138 lm/W	55	7594	>80	>60,000	>100,000
BS101LED-ECO-4HT-HO-WT30-120-277V	4 ft	139 lm/W	55	7644	>80	>60,000	>100,000
BS101LED-ECO-4HT-HO-WT40-120-277V	4 ft	140 lm/W	55	7726	>80	>60,000	>100,000
BS101LED-ECO-4HT-HO-WT50-120-277V	4 ft	144 lm/W	55	7919	>80	>60,000	>100,000







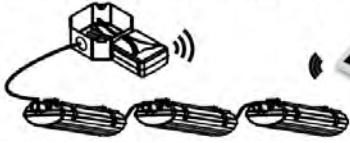

ELECTRICAL RATING

PRODUCT	NOMINAL POWER (W)	AC CURRENT (A) AC VOLTAGE		FREQUENCY (HZ)	DC VOLTAGE (V)	DC CURRENT (MA)
		120 V	277 V			
BS101LED-ECO-HT-LO	35	0.30	0.13	50/60	45	650
BS101LED-ECO-HT-HO	55	0.47	0.20	50/60	45	1000

DIMMER COMPATIBILITY

DIMMER	COMPATABILITY	
	ON/OFF	DIMMING
LEVITON - AWRMG-7	YES	YES
LUTRON - DIVE - DVSTV	YES	YES
LUTRON - DIVE - DVTV	YES	YES
WATT STOPPER - DCLV1	YES	YES

BEGHELLI LIGHTING CONTROL SOLUTIONS

DAISY CHAIN FIXTURES (RELAY)			EXTERNAL NODE & SENSOR (OS)	
<p>RLY* Wireless Relay (Damp Location)</p>  <p>Max range: 100ft Max fixtures: 20</p>	<p>EMDCB* Remote Sensor (Damp Location)</p> 	<p>SW1* Single Switch (Damp Location)</p> 	<p>OS (Beghelli standard) (Wet Location)</p> <p>(EXTERNAL)</p> 	<p>SW1* Single Switch (Damp Location)</p> 
<p>External occ sensor options: OSM1*, SBOR, CRMB9, OSFSP221, etc.</p>				
INTEGRATED NODE (NOD)				
<p>NOD* Node</p> 	<p>EMDCB* Remote Sensor (Damp Location)</p> 	<p>SW1* Single Switch (Damp Location)</p> 		

* Magnum control options also available (RLYM1 relay, MLM1 sensor, SW1M1 switch, NODM1 node and OSM1 sensors)

**Beghelli offers standard wired and wireless control solutions. Beghelli fixtures are compatible with most control solutions available in the market, consult factory for more details.

WARRANTY: 5 year warranty, see website for full warranty details.