

CASTEX 310



HAZARDOUS

■ The **CASTEX 310** is a hazardous location luminaire rated for use in:

- Class I, Division 1, Groups C, D
- Class I, Division 2, Groups A, B, C, D
- Class II, Division 1, Groups E, F, G
- Class II, Division 2, Groups F, G
- Class III
- Class I, Zone 1, Group IIB
- Class II, Zone 21, Group IIIC
- UL1598 (Wet Location) & UL1598A (Marine)
- Temperature Code: T4

■ **MOUNTING:** Adjustable surface ceiling/ wall mount bracket standard

■ **HOUSING:** Die-cast, 6mm thick ADC12 aluminum alloy body with marine grade RAL7040 powder coat finish

■ **COLOR TEMPERATURE:** 5000K standard

■ **DIFFUSER:** 8 mm tempered glass, wide distribution 120° standard

■ **LUMENS:**

- VLO: 60W @ 8400 lm
- LO: 80W @ 11200 lm
- MO: 100W @ 14000 lm (EM: 15W @ 2100 lm)
- HO: 150W @ 21000 lm (EM: 15W @ 2100 lm)
- VHO: 250W @ 35000 lm (EM: 15W @ 2100 lm)

■ **DIMMING:** 0-10VDC dimming standard

■ **OPERATING TEMP:**

- HT (AC Only): -40°F to 140°F (-40°C to 60°C)
- SA (AC & EM): 14°F to 140°F (-10°C to 60°C)



■ **WEIGHT:** 30.9 lbs to 46.3 lbs

■ **APPLICATION:** The **CASTEX 310** is ideal for use in extreme hazardous and corrosive locations such as oil and gas, chemical, marine and food industries. This unit is suitable for high humidity, high dust, high temperature, high wind and high vapor locations.

ORDERING INFORMATION

Example: HZCAS310HTMODIMWT50120-277V

MODEL	OPERATION	OUTPUT	DIMMING	COLOR TEMP	INPUT	OPTIONS
HZCAS310	HT (AC only)	VLO	DIM (0-10V dimming)	WT50 ² (5000K)	120-277V	BAA (Buy American Act)
	SA ¹ (AC & EM)	LO				
		MO				
		HO				
		VHO				
ACCESSORIES						
						HZCH39 (39" chain)
						HZPK12 (12" pendant stem)
						HZHOOK (hook mount)
						HZWM25 (25° wall mount)
						HZJBOX (J-box)
						HZWM90 (90° wall mount)

NOTE 1: Integral emergency available in MO, HO and VHO outputs only, contact factory for lead time

NOTE 2: Other color temperatures available (2700K to 7000K), contact factory for lead time

NOTE 3: High voltage option available (200 to 480V), contact factory for lead time

NOTE: Surface ceiling/ wall mount is standard

DIMENSIONS

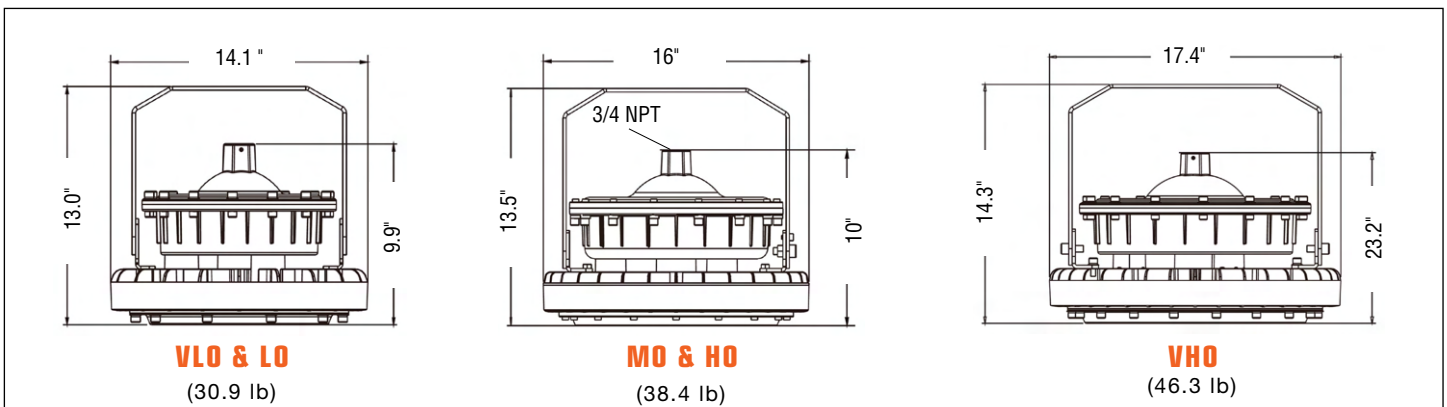

MOUNTING

Standard
(surface/ceiling mount bracket)

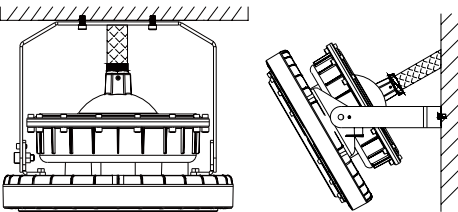

Hook Mount
(HZHOOK)

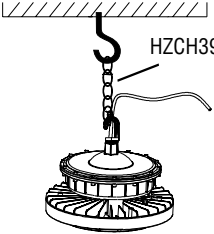

HZCH39

Pendant Mount
(HZPK12)

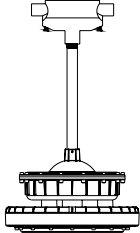

Wall Mount
(HZWM9)

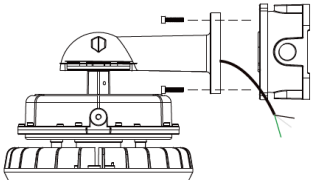

NOTE: Power cord cannot be exposed. Hazardous conduit or hazardous J-box mounting required. Order hazardous J-box (HZJBOX) separately.

Note: HZPK12 does not include hazardous rated J-box. HZJBOX must be ordered separately.

NOTE: Hazardous J-box included with wall mount

Compatible with NPT1 thread with an adapter

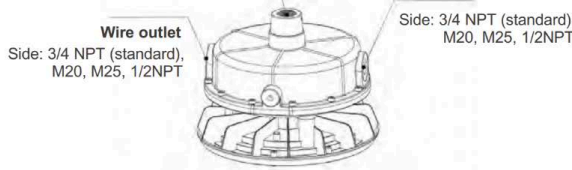

Top: 3/4 NPT (standard), M25
Side: 3/4 NPT (standard), M20, M25, 1/2NPT
Wire outlet

PHOTOMETRICS

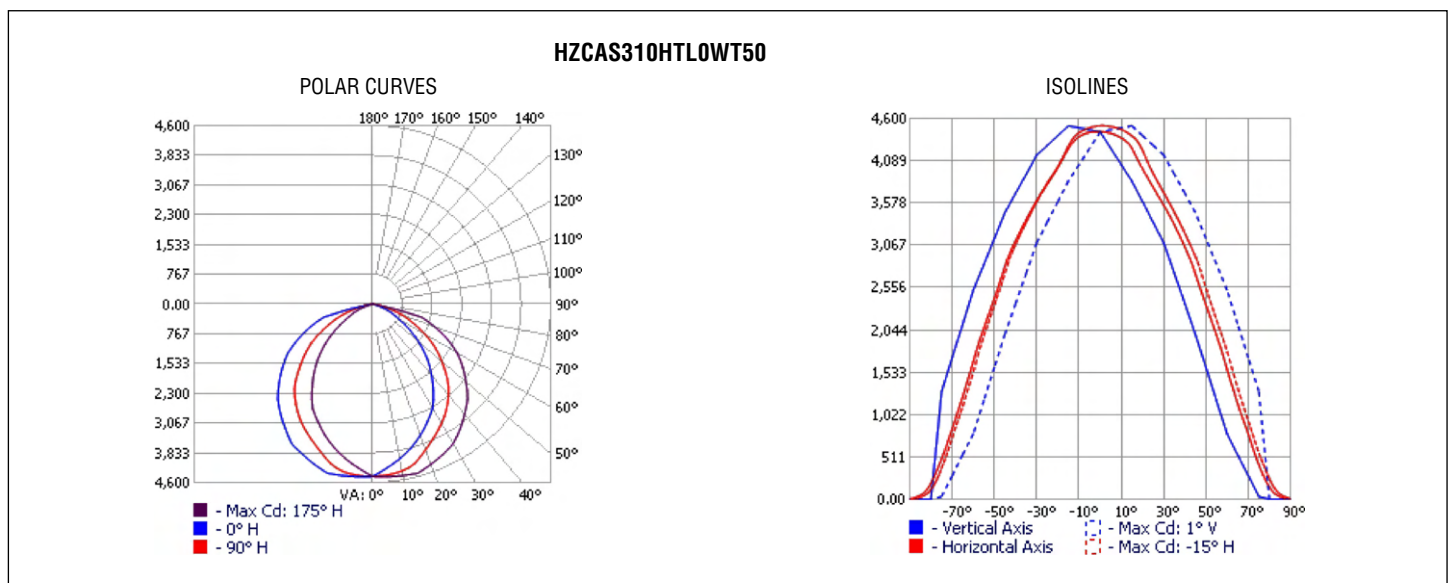

CASTEX 310

ADDITIONAL INFORMATION

ENERGY CHART

MODEL (5000K CCT)	EFFICACY	CONSUMPTION WATTAGE	LUMEN OUTPUT	CRI	L70 (HRS) @ 55°C
HZCAS310HTVLO	140 LPW	60	8400 lm	>70	>150,000
HZCAS310HTLO	140 LPW	80	11200 lm	>70	>150,000
HZCAS310HTM0	140 LPW	100	14000 lm	>70	>150,000
HZCAS310HTH0	140 LPW	150	21000 lm	>70	>150,000
HZCAS310HTVH0	140 LPW	250	35000 lm	>70	>150,000

ELECTRICAL RATING

PRODUCT	NOMINAL POWER (W)	AC CURRENT (A) AC VOLTAGE		FREQUENCY (HZ)	DC VOLTAGE (V)	DC CURRENT (MA)
		120 V	277 V			
HZCAS310HTVLO	60	0.51	0.22	50/60	48	1250
HZCAS310HTLO	80	0.68	0.29	50/60	48	1670
HZCAS310HTM0	100	0.85	0.37	50/60	48	2090
HZCAS310HTH0	150	1.28	0.55	50/60	48	3130
HZCAS310HTVH0	245	2.10	0.91	50/60	48	5210

- **WARRANTY:** 5 years, see website for full warranty details.