

Type: _____

Project: _____

ACCIAIO® 940



BX940LED

- **ACCIAIO® BX940LED** is an industrial grade vapor tight solution that features easily upgradeable technology, convenient installation and a robust design that is ideal for most mid and high bay commercial and light industrial applications.
- **HOUSING:** 24 gauge steel construction with die-cast aluminum end caps. Finished with zinc enriched polyester powder coat gray (RAL7040). Optional 24 gauge stainless steel housing is available.
- **DIFFUSER:** Impact resistant 4mm frosted tempered glass diffuser with pressed silicon gasket is integrated into the housing for optimal ingress protection.
- **LUMENS:**
 - LO: 12,900 to 13,700 lm
 - HO: 20,700 to 21,900 lm
- **OPERATING TEMP:**
 - HT (AC Only) -40°C to 40°C (-40°F to 104°F)
 - SA (AC & EM) 0°C to 40°C (32°F to 104°F)
- **WEIGHT:** 35 lbs / 15.88 kg



- **APPLICATION:** The **ACCIAIO® BX940LED** is a versatile luminaire ideal for a wide range of applications including: warehouses, canopies, loading docks, gymnasiums, pool areas, manufacturing facilities and waste water treatment facilities.
- **INTERNAL:** 0-10V dimming driver (1% - 100%), 120-277V or 347-480V input. Dual mid-power white LED, >80CRI. All components mounted to a 22 gauge steel reflector with white powder coat finish. Optional integrated emergency pack provides 1367 lumens during power failure.

ORDERING INFORMATION

7J3? B>7, 4J +&" >76 & F : A I F&" # \$" Z\$) H

MODEL	LENGTH	OPERATION	OUTPUT	COLOR TEMP	INPUT	MOUNTING	OPTIONS ⁶
BX940LED	4 (ft)	HT (AC only)	LO	WT30 (3000K)	120-277V	blank (surface mount std)	EM ¹ (field installable remote EM driver)
		SA ¹ (AC & EM)	HO	WT40 (4000K)	347-480V		FP (fuse protection - 3A)
				WT50 (5000K)			NOD ² (integrated node)
CONTROLS & ACCESSORIES							
2ACxBX940 ⁴ (adjustable aviation cable, x=length: 50=50", 72=72")			EMDCB ² (BT wireless motion & lux sensor)			RLY ² (BT wireless motion & lux sensor)	OS ^{2,3} (external occupancy sensor)
2CH48 ⁴ (48" chain hang kit, field cuttable)			HHRFSIR ⁷ (remote for FSP221)			SBXL (seismic bracket)	SP (surge protection - 10KA)
2PKxBX940 ^{4,5} (double pendant kit, white, x=length)			MLM1 ² (wireless motion and lux sensor)			SW1 ² (single BT rocker wall switch)	

NOTE 1: Emergency pack T20, 120-277V, 10W, 1367 lm
 NOTE 2: Beggelli offers wireless & powerless control solutions, contact factory for more details
 NOTE 3: OS is std Beggelli sensor (Magnum OSM1, CRMB9, OSFSP221, SBOR & other sensors also available)
 NOTE 4: Consult factory for non-standard lengths

NOTE 5: Standard pendant lengths "x" = 12 (12"), 24 (24") and 48 (48")
 NOTE 6: Gray housing is standard
 NOTE 7: OSFSP221 requires HHRFSIR handheld remote accessory

TECHNICAL INFORMATION

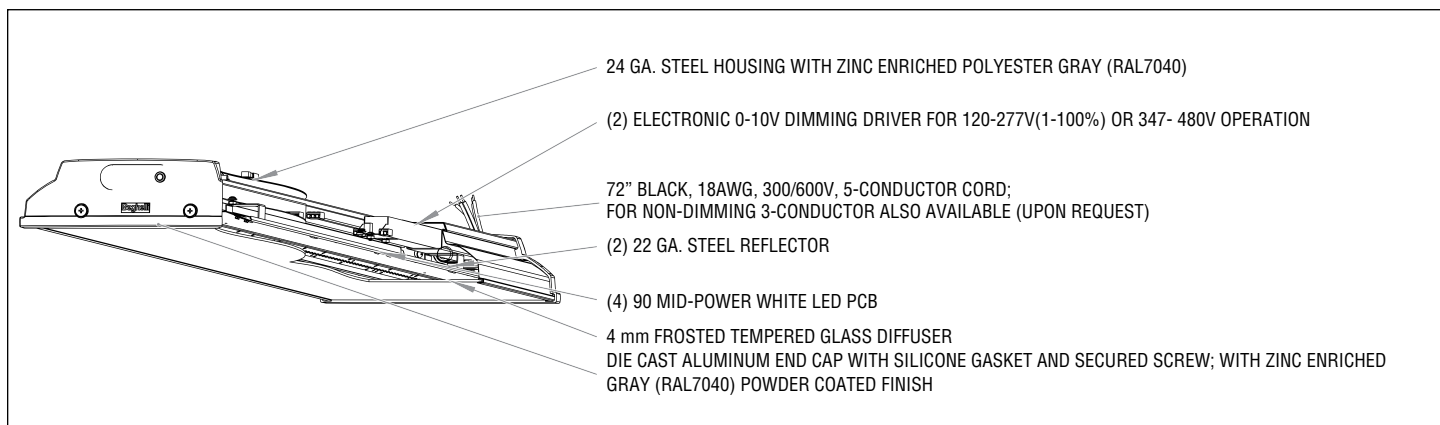

DIMENSIONS

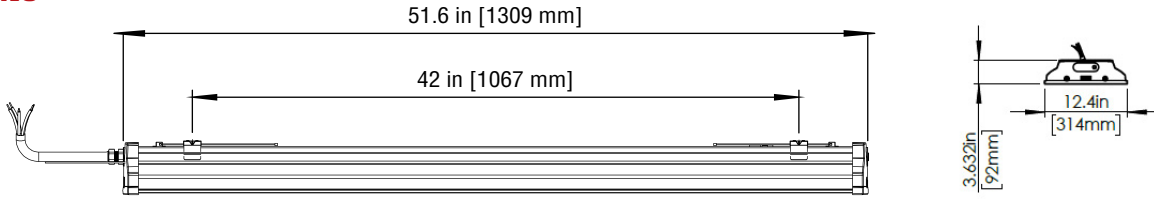

MOUNTING OPTIONS

SURFACE MOUNTING <i>(Standard)</i> (hardware by others)	Aviation Cable Kit (2AC50BX940, 2AC72BX940)	Chain Hang Kit (2CH48)	Pendant Kit (2PK12BX940, 2PK24BX940, 2PK48BX940)	Seismic Bracket (SBXL)

PHOTOMETRICS

BX940LED 4HT LO WT40 120-277V

POLAR CURVES

CHARACTERISTICS

- Electronic driver
- LED 4000°K
- Lumen Per Lamp: 41.4 (384 lamps)
- Total Lamp Lumen: 15897.6
- Luminaire Lumen: 13667
- Total Luminaire Efficiency: 86 %
- Luminaire Efficacy Rating (LER): 137
- Total Luminaire Watts: 100
- Ballast Factor: 1.00
- CIE Type: Direct

CHARACTERISTICS

- Electronic driver
- LED 4000°K
- Lumen Per Lamp: 66.2 (384 lamps)
- Total Lamp Lumen: 25420.8
- Luminaire Lumen: 21856
- Total Luminaire Efficiency: 86 %
- Luminaire Efficacy Rating (LER): 137
- Total Luminaire Watts: 160
- Ballast Factor: 1.00
- CIE Type: Direct

ISOLINES

Zonal Lumen Summary				
Zone	Lumen	%Lamp	%Fixt	
0-20	1863.91	11.70	13.60	
0-30	4011.53	25.20	29.40	
0-40	6621.69	41.70	48.40	
0-60	11495.23	72.30	84.10	
0-80	13552.56	85.20	99.20	
0-90	13666.72	86.00	100.00	
10-90	13192.66	83.00	96.50	
20-40	4757.79	29.90	34.80	
20-50	7413.97	46.60	54.20	
40-70	6317.76	39.70	46.20	
60-80	2057.33	12.90	15.10	
70-80	613.11	3.90	4.50	
80-90	114.16	0.70	0.80	
90-110	0.71	0.00	0.00	
90-120	0.71	0.00	0.00	
90-130	0.71	0.00	0.00	
90-150	0.71	0.00	0.00	
90-180	0.71	0.00	0.00	
110-180	0.00	0.00	0.00	
0-180	13667.43	86.00	100.00	

Total Luminaire Efficiency = 86.00%

BX940LED 4HT HO WT40 120-277V

POLAR CURVES

CHARACTERISTICS

- Electronic driver
- LED 4000°K
- Lumen Per Lamp: 41.4 (384 lamps)
- Total Lamp Lumen: 15897.6
- Luminaire Lumen: 13667
- Total Luminaire Efficiency: 86 %
- Luminaire Efficacy Rating (LER): 137
- Total Luminaire Watts: 100
- Ballast Factor: 1.00
- CIE Type: Direct

CHARACTERISTICS

- Electronic driver
- LED 4000°K
- Lumen Per Lamp: 66.2 (384 lamps)
- Total Lamp Lumen: 25420.8
- Luminaire Lumen: 21856
- Total Luminaire Efficiency: 86 %
- Luminaire Efficacy Rating (LER): 137
- Total Luminaire Watts: 160
- Ballast Factor: 1.00
- CIE Type: Direct

ISOLINES

Zonal Lumen Summary				
Zone	Lumen	%Lamp	%Fixt	
0-20	2978.92	11.70	13.60	
0-30	6408.09	25.20	29.30	
0-40	10581.28	41.60	48.40	
0-60	18382.98	72.30	84.10	
0-80	21672.39	85.30	99.20	
0-90	21854.5	86.00	100.00	
10-90	21095.68	83.00	96.50	
20-40	7602.36	29.90	34.80	
20-50	11856.43	46.60	54.20	
40-70	10110.1	39.80	46.30	
60-80	3289.41	12.90	15.10	
70-80	981.01	3.90	4.50	
80-90	182.10	0.70	0.80	
90-110	1.09	0.00	0.00	
90-120	1.10	0.00	0.00	
90-130	1.10	0.00	0.00	
90-150	1.10	0.00	0.00	
90-180	1.10	0.00	0.00	
110-180	0.00	0.00	0.00	
0-180	21855.59	86.00	100.00	

Total Luminaire Efficiency = 86.00%

ACCIAIO® BX940LED

ADDITIONAL INFORMATION

ENERGY CHART

MODEL	LENGTH	EFFICACY	CONSUMPTION WATTAGE	LUMEN OUTPUT	CRI	L70 (HRS)
BX940LED 4HT LO WT40 120-277V	4 ft	138 lm/W	100	12,900 - 13,700	>80	>100,000
BX940LED 4HT HO WT40 120-277V	4 ft	137 lm/W	160	20,700 - 21,900	>80	>100,000







ELECTRICAL RATING

PRODUCT	NOMINAL POWER (W)	AC CURRENT (A) AC VOLTAGE				FREQUENCY (HZ)	DC VOLTAGE (V)	DC CURRENT (MA)
		120V	277V	347V	480V			
BX940LED 4HT LO	100	0.85	0.37	0.29	0.21	50/60	46	1000
BX940LED 4HT HO	160	1.36	0.59	0.47	0.34	50/60	46	1000
BX940LED 4SA LO	105	0.89	0.39	0.31	0.22	50/60	46	1000
BX940LED 4SA HO	165	1.40	0.61	0.49	0.35	50/60	46	1000

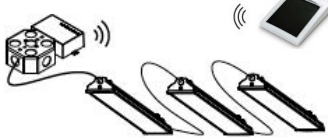
DIMMER COMPATIBILITY

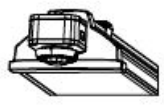
DIMMER	COMPATIBILITY	
	ON/OFF	DIMMING
LEVITON - AWRMG-7	YES	YES
LUTRON - DIVA - DVSTV	YES	YES
LUTRON - DIVE - DVSTV	YES	YES
WATT STOPPER - DCLV1	YES	YES

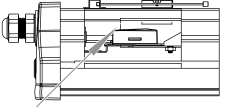
BEGHELLI LIGHTING CONTROL SOLUTIONS

DAISY CHAIN FIXTURES (RELAY)			EXTERNAL NODE & SENSOR (OS)	
<p>RLY* Wireless Relay (Damp Location)</p> 	<p>EMDCB* Remote Sensor (Damp Location)</p> 	<p>SW1* Single Switch (Damp Location)</p> 	<p>OS* Beghelli Standard (Wet Location)</p>  <p>(EXTERNAL KNOCKOUT)</p>	<p>SW1* Single Switch (Damp Location)</p> 
<p>External occ sensor options: OSM1*, SBOR, CRMB9, OSFSP221, etc.</p>				
INTEGRATED NODE (NOD)				
<p>NOD* Node</p>  <p>NODE (INTEGRATED)</p>	<p>EMDCB* Remote Sensor (Damp Location)</p> 	<p>SW1* Single Switch (Damp Location)</p> 	<p>*Magnum control options are also available (NODM1 node, OSM1 sensor, RLYM1 relay, SW1M1 switch)</p> <p>**Beghelli offers standard wired and wireless control solutions. Beghelli fixtures are compatible with most control solutions available in the market, consult factory for more details.</p>	

■ **WARRANTY:** 5 years, see website for full warranty details.