

# BOXLED®



## HIGH BAY

- **BOXLED®** High-Bay Luminaires for Commercial and Industrial applications.
- **REFLECTOR:** Parabolic aluminum louvers available with medium, wide, or asymmetrical distribution options. Micro prismatic tempered glass diffuser provides optimized light distribution for a visually comfortable and glare free environment.
- The **BOXLED®** is wet location, IP66 rated. Durable powder coated die-cast construction provides resistance against corrosion, flame and chemicals.
- **LUMENS:** LO: 14993 up to 16430 lm  
HO: 23776 up to 26076 lm
- **OPERATING TEMP:**  
HT: (AC Only) -22°F to 104°F (-30°C to 40°C)  
EM: 32°F to 104°F (0°C to 40°C)
- **WEIGHT:** 17 lbs / 7.7 kg



**APPLICATION:** The **BOXLED®** is ideal for damp or wet applications including warehouses, factories, gymnasiums, loading docks, logistic centers, mining, carwash, agriculture and open ceiling environments.

### CONFIGURATIONS

MODEL	OPERATION	OUTPUT	DISTRIBUTION	COLOR TEMP	INPUT	MOUNTING	OPTIONS
BL736LED	HT	LO	MBD (medium beam)	WT30 (3000K)	120-277V	SM (surface mount)	EM (emergency back up-remote)
		HO	WBD (wide beam)	WT40 (4000K)	347V	AC (aviation cable)	EOSL (external occupancy sensor - LOGICA)
			ASY (asymmetric beam)	WT50 (5000K)	480V	CH (chain hang kit)	FP (fuse protection - 3A)
						PK (pendant kit)	NODL (integrated node - LOGICA)
						SVLPK (swivel pendant kit)	SP (surge protector - 10KA)
						HK (hook mount)	WG (wire-guard)

NOTE 1: Surface mount is standard.

NOTE 2: Specify length for AC: 50", 72", 100", 150", 250"; specify for others.

NOTE 3: Specify length for CH: 12", 24", 36", 48", specify for others.

NOTE 4: Specify length for PK: 12" 24", 48", specify for others.

NOTE 5: Title 20 Field installation emergency pack (120-277V); LO & HO: 17W; 2292 lm; (wet location required nema box).

NOTE 6: Logica (Beghelli wireless and powerless control solutions). Contact factory for more details.

### TECHNICAL INFORMATION

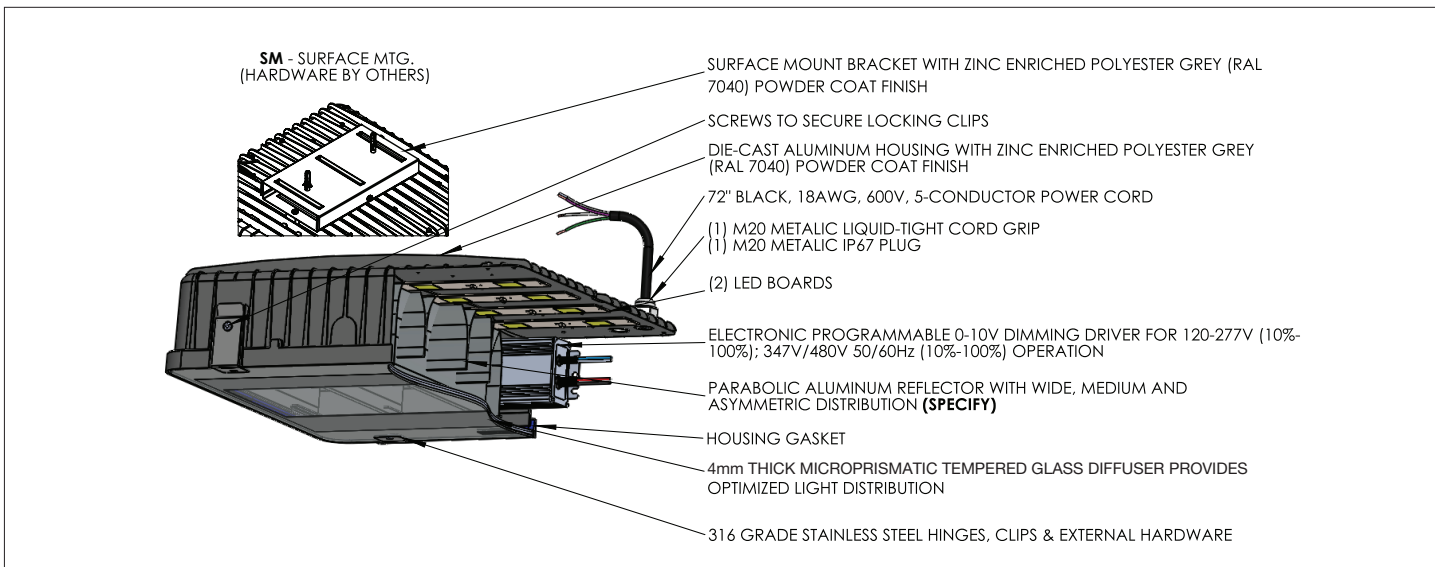

## DIMENSIONS

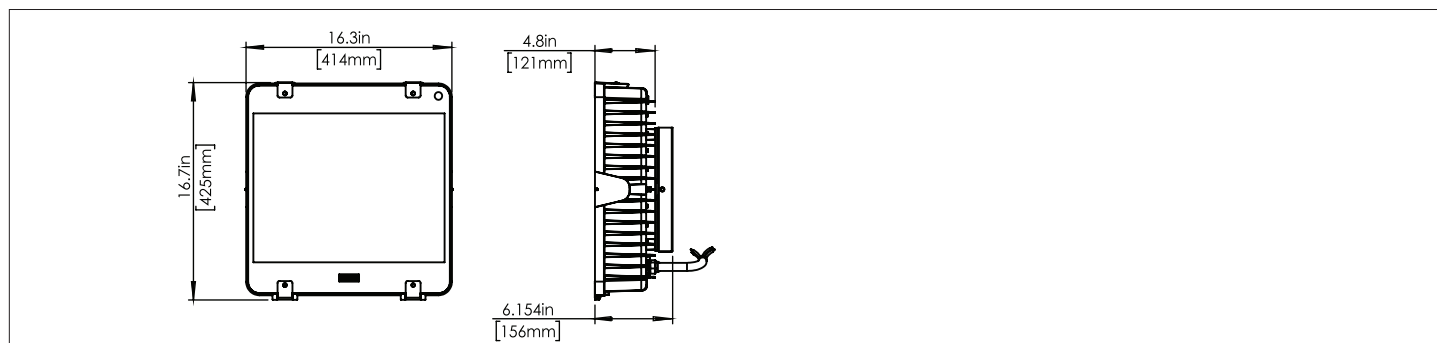

## MOUNTING OPTIONS

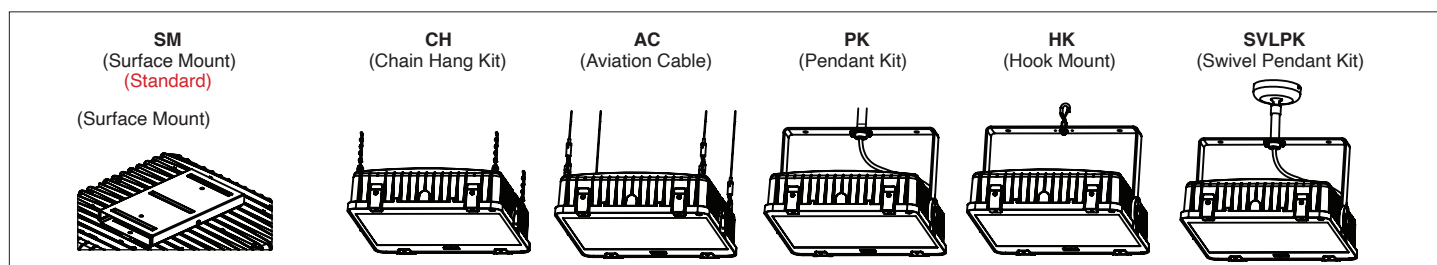

## PHOTOMETRICS

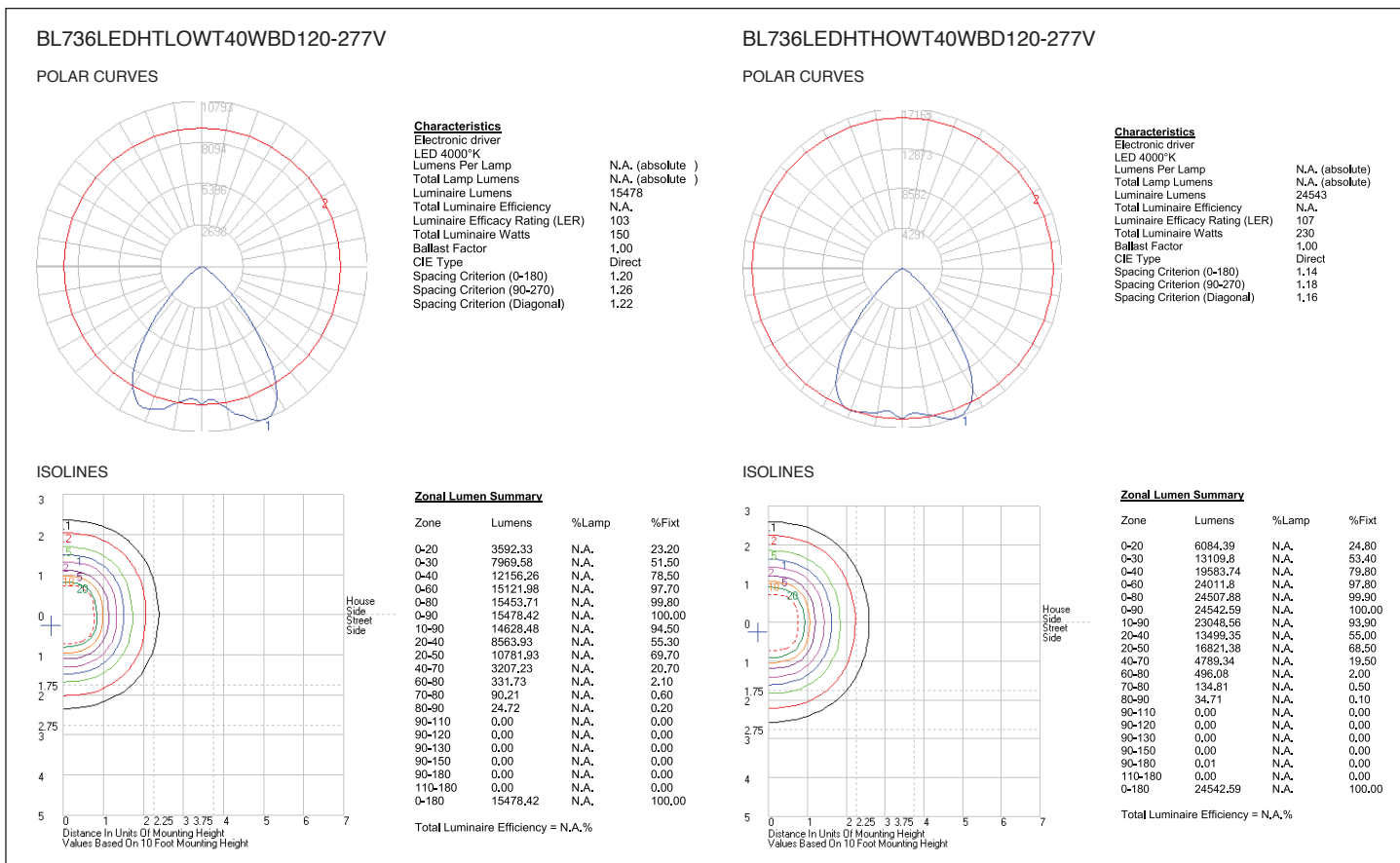

**ELECTRICAL RATING**

**DIMMER COMPATIBILITY**

PRODUCT	NOMINAL POWER (W)	AC CURRENT (A)		FREQUENCY (HZ)	DC VOLTAGE (V)	DC CURRENT (MA)
		120V	277V			
BL736LED-HT-LO	150	1.28	0.55	50/60	50	2700
BL736LED-HT-HO	230	1.96	0.85	50/60	50	4100



  

DIMMER	COMPATABILITY	
	ON / OFF	DIMMING
LEVITON - AWRMG - 7	YES	YES
LUTRON - DIVE - DVSTV	YES	YES
LUTRON - DIVE - DVTV	YES	YES
WATT STOPPER DCLV1	YES	YES

**ENERGY CHART**

MODEL	EFFICACY	CONSUMPTION WATTAGE	LUMEN OUTPUT	CRI	L70 (hrs.)
BL736LED-HT-LO-WBD-WT30-120-277V	100 lm/W	150	14993	>80	>60,000
BL736LED-HT-LO-WBD-WT40-120-277V	103 lm/W	150	15470	>80	>60,000
BL736LED-HT-LO-WBD-WT50-120-277V	110 lm/W	150	16430	>80	>60,000
BL736LED-HT-HO-WBD-WT30-120-277V	103 lm/W	230	23776	>80	>60,000
BL736LED-HT-HO-WBD-WT40-120-277V	107 lm/W	230	24543	>80	>60,000
BL736LED-HT-HO-WBD-WT50-120-277V	113 lm/W	230	26076	>80	>60,000

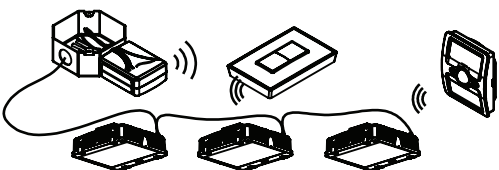
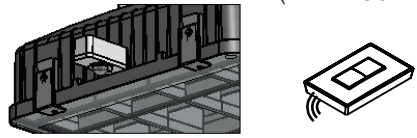
**LOGICA (WIRELESS & POWERLESS LIGHTING CONTROL SOLUTIONS)**

DAISY CHAIN FIXTURES (RLYL)			EXTERNAL NODE & SENSOR (EOSL) (WET LOCATION)	
<p><b>LOG-RLY</b> WIRELESS RELAY (DAMP LOCATION)</p>	<p><b>LOG-ESRP</b> SWITCH (ACCESSORY) (DAMP LOCATION)</p>	<p><b>LOG-ML2</b> REMOTE SENSOR (ACCESSORY) (DAMP LOCATION)</p>	<p><b>LOG-HBKO10V/HBKOD</b> NODE &amp; SENSOR (KNOCK-OUT)</p>	<p><b>LOG-ESRP</b> SWITCH (ACCESSORY) (DAMP LOCATION)</p>
				
<p>DAISY CHAIN - 13 FIXTURES; 18 FT MAX. (base on 12AWG) (daisy chain by others)</p> <p>FOR DETAILS PLEASE SEE LIGHTING CONTROL SOLUTION CONFIGURATION.</p>			<p><b>INTEGRATED NODE (NODL)</b></p>	
<p><b>LOG-10V12/DRD</b> (NODE 0-10V/DALI) (INTEGRATED)</p>	<p><b>LOG-ESRP</b> SWITCH (ACCESSORY) DAMP LOCATION</p>	<p><b>LOG-ML2</b> REMOTE SENSOR (ACCESSORY) DAMP LOCATION</p>		
				

■ **WARRANTY:** 5 year warranty, see website for full warranty details.