

# BRAVADO™ UNIT



Industrial Application Emergency

Job/Location: _____	Job Type: _____
Contractor: _____	Date: _____
Prepared By: _____	



## ■ specifications: internal

The **BRAVADO UNIT** has a 120/277V input and designed to perform in applications where the environment would punish any standard unit. The entire internal cavity is protected from moisture ingress by an extremely resilient gasket. The gasketing always holds its original form and has “memory retention” so that it effectively and consistently protects the **BRAVADO UNIT** from moisture. The standard lead acid battery or optional nickel cadmium battery provides a minimum emergency duration of 90 minutes.

## ■ specifications: external

The **BRAVADO UNIT** is constructed from 0.100” thick, heavy duty cast aluminum. Stainless steel tamper resistant screws are standard and ensure the integrity of the battery unit. The **BRAVADO UNIT** comes standard in an industrial gray color although custom color options are available upon request. The **BRAVADO UNIT** comes standard with an LED status indicator and test switch under the lens. The lens is constructed from a vandal resistant polycarbonate for maximum durability. Lamp and reflector assemblies are offered in a fully adjustable, high output MR16 halogen or LED configurations. Universal mounting pattern and key hole slots are cast into the backplate. Stainless steel mounting straps are supplied for surface mounting.

## ■ dimensions (in,mm)

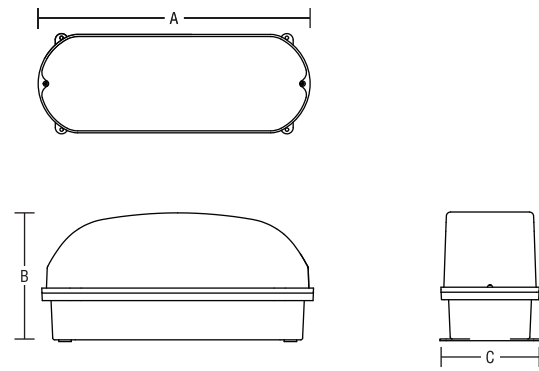

Series	A”	B”	C”
BRV	16.25”	7.5”	6”
	413mm	191mm	152mm

## ■ ordering logic

EXAMPLE: BRV 636 2MR167WLED AT

Series	Operation	Pb-A (Capacity)	Ni-Cd (Capacity)	Lamp Type	Options
BRV	6 (6V)	18 (6V)	22 (6V)	See lamp selection	AM (ammeter)
	12 (12V)	27 (6V, 12V)	42 (6V, 12V)	guide on next page	AT <sup>1</sup> (autotest)
		36 (6V, 12V)			FAI <sup>2</sup> (fire alarm interface)
		60 (6V, 12V)			IH (internal heater- specify AC voltage)
					IRT <sup>3</sup> (infrared testing)
					MT (magnetic test switch)
					NC <sup>4</sup> (nickel-cadmium battery)
					RC <sup>5</sup> (remote capable)
					VM (voltmeter)
					WG (wireguard)

NOTE 1: Includes an automatic time delay function specify 0, 5, 10 or 20 mins.

NOTE 2: Specify type-open/closed dry contact.

NOTE 3: HHC (controller for IRT) should be ordered separately (item code:476000021).

NOTE 4: NC (select wattage/voltage from Ni-Cd column).

NOTE 5: See Remotes <https://beghelliusa.com/product-category/emergency/remote-heads/>

## ■ specifications: electrical

**BATTERY:** The **BRAVADO UNIT** is designed with a maintenance free, sealed valve regulated lead acid battery that provides a minimum emergency duration of 90 minutes. Recharge time of the battery is forty-eight [48] hours. An optional Nickel-Cadmium battery is available. The battery operating temperature without the internal heater/thermostat option is 40°C maximum and 10°C minimum; with the internal heater (IH) option the minimum battery operating temperature is -20°C.

**CIRCUIT:** The **BRAVADO UNIT** utilizes a high-efficiency two stage charger providing precise float voltage control with low voltage disconnect protection. All components used in the circuitry are temperature compensated. The charger also has brownout and short circuit protection. Charger status is easily determined via a dual diagnostic LED display which indicates AC/ON and High Charge. A magnetic test switch allows maintenance personnel to quickly determine the operational status of the unit and lamp load.

## ■ specifications: mechanical

The **BRAVADO UNIT** is constructed from a durable, fully gasketed diecast aluminum housing and polycarbonate lens. Universal mounting pattern and key hole slots are cast into the mounting backplate. Stainless steel mounting straps are supplied for surface mounting. Lamp loads are connected to the emergency power supply with sturdy terminal connectors. These connectors allow for a large gauge of wire to be used, increasing the flexibility or installation. The **BRAVADO UNIT** is supplied standard in a durable gray powder coat, baked finish. Other colors are available, including color matching, please specify. CSA C22.2 No. 141 Performance Certified.

## ■ specifications: extreme weather







The **BRAVADO UNIT** has been designed to perform in applications where the environment would punish any standard unit. The entire internal cavity is protected from moisture ingress by an extremely resilient gasket. The gasketing always holds its original form and has “memory retention” so that it effectively and consistently protects the **BRAVADO UNIT** from moisture.

## ■ sanitation listed (SL)

The **BRAVADO UNIT** is sanitation approved. The Intertek verified splash zone listing is equivalent to the NSF Standard 2, meeting the rigorous sanitation, electrical safety and performance standards of food service environments.

## ■ autotest

The Beghelli Autotest automatically initiates a five minute discharge/diagnostic test every month and two 90-minute discharge/diagnostic tests every 6 months. Twenty-four hours following the first 6 month test, the unit retests again to ensure that the charger has completely recharged the battery. The lamps and connected remote load will come on during these tests. The tests exercise the battery to optimize its capacity and analyse the unit’s emergency operation performance. Any malfunction of the transfer circuit, batteries or emergency lamps will cause the multi-colour DIAGNOSTIC LED on the unit to indicate the problem. The DIAGNOSTIC indications will remain latched (stay on) in the system until corrected or reset.

-  **Steady Green :** Normal Operation
-  **Flashing Green :** AC Interruption in Last 48 Hours
-  **Steady Yellow :** Lamp Circuit Malfunction
-  **Flashing Yellow :** Auto-test or Manual Test in Progress
-  **Steady Red :** Battery Failed Testing
-  **Flashing Red :** Battery Disconnected or Charger Malfunction

## ■ lamp selection:

	6V	12V
MR16	-	50W
MR16 LED	5, 7W	2W, 5W, 7W

## ■ model rating guide

Model	Voltage	Wattage			
		90min	120min	180min	240min
BRV 618	6	18	13	9	6
BRV 622 NC	6	22	16	11	8
BRV 636	6	36	27	18	13
BRV 642 NC	6	42	31	21	15
BRV 654	6	54	41	27	20
BRV 660	6	60	45	30	22
BRV 1236	12	36	27	18	13
BRV 1242 NC	12	42	31	21	15
BRV 1260	12	60	45	30	22

NOTE 1: Not available with all options.

## ■ warranty

The **BRAVADO UNIT** comes with a 3-year factory warranty. Deliberate damage, misuse, improper installation effectively cancel the warranty.