INSTRUCTIONS

IMPORTANT SAFEGUARDS

When using electrical equipment, basic safety precautions should always be followed including the following:

1. **READ AND FOLLOW ALL SAFETY INSTRUCTIONS**
2. Disconnect power before performing work on electrical equipment.
3. Do not use outdoors.
4. Do not let power cords touch hot surfaces and do not mount near gas or electric heaters.
5. Use caution when servicing batteries. Battery acid can cause burns to skin and eyes. If acid is spilled on skin or eyes, flush with fresh water and contact a physician immediately.
6. Equipment should be mounted in locations and at heights where unauthorized personnel will not readily subject it to tampering.
7. The use of accessory equipment not recommended by Beghelli USA, may cause an unsafe condition, and will void the unit's warranty.
8. Do not use this equipment for other than its intended purpose.
9. Servicing of this equipment should be performed by qualified service personnel.
10. **SAVE THESE INSTRUCTIONS!**

INSTALLATION

WALL MOUNT - SINGLE FACE:

1. Extend unswitched 24 hour AC supply of rated voltage to junction box or appropriate wiring (supplied by others). Leave at least eight (8) inches of slack wire. The circuit should not be energized at this time.
2. Remove the exit sign faceplate by unscrewing the faceplate cover screw and sliding the faceplate down and out of the exit frame (Figure 2). Take care not to damage red fibre which is loose behind exit faceplate.
3. Remove the exit sign universal canopy kit.
4. Knock out the appropriate mounting pattern and/or wire pass-thru hole on the exit back plate to fit the junction box or wiring connector being used (supplied by others).
5. Bring wires through the back of the sign and mount the exit securely in place. Screw directly to junction box if possible.
6. Connect supply as per diagram provided (Figure 5). **Insulate unused wire!**
CAUTION! - Failure to insulate unused wire may result in a shock hazard or unsafe condition as well as equipment failure.
7. Route wires and secure them in place.
8. Remove any directional chevron arrows to be indicated as required from the exit stencil.
9. Replace the exit faceplate together with red fibre and secure with the faceplate cover screw.
10. Turn on the AC voltage supply.

CEILING/END MOUNT - SINGLE OR DOUBLE FACE:

1. Follow steps 1 to 3 of Wall Mounting instructions above.
2. If double face is required then remove the backplate cover screw and slide the backplate down and out from exit frame. Exits signs that are specified double face will already have the second/rear faceplate installed.
3. On the top and both sides of the exit there are three (3) holes for the canopy - two (2) for the mounting screws and one (1) wire pass-thru hole. Knock out the three appropriate canopy mounting holes for your installation (Figure 3).
4. Secure the canopy to the exit sign using the supplied 1 inch screws and washer nuts and the snap the wire pass-thru hole plastic bushing into the wire pass-thru hole in the centre of the canopy (Figure 3).
5. Bring wires through the wire pass-thru and connect supply per diagram provided (Figure 5).
6. Secure the exit to the wall or ceiling using the supplied 1-1/2 inch screws and nuts. Screw directly to junction box if possible. A universal spider plate is supplied to allow for exit sign placement adjustment or connection to a variety of electrical boxes (Figure 4).
7. For double face exits install the second/rear faceplate and red fibre and secure with the back plate cover screw.
8. Follow steps 7 to 10 of Wall Mounting instructions above.

SELF-POWERED:

1. For models STX-SA, plug the battery into the circuit board per (Figure 5) self-powered sign.

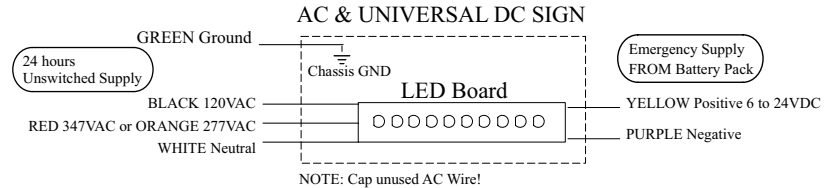
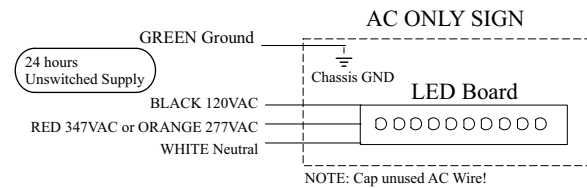
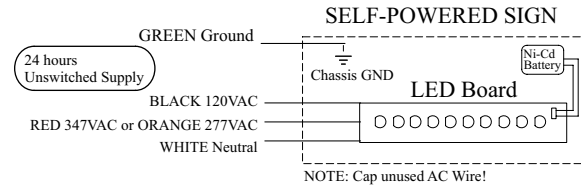
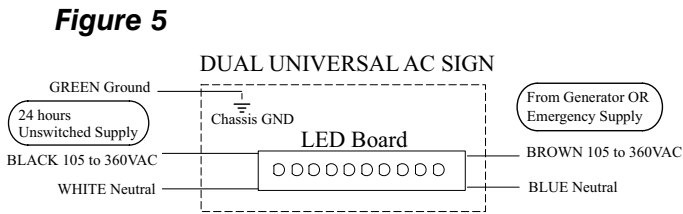
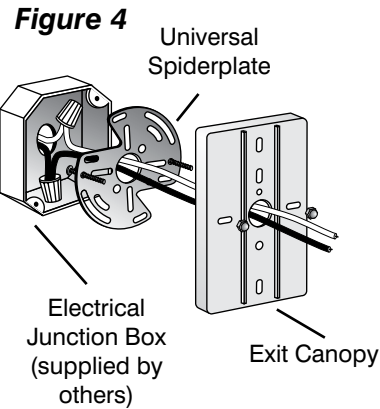
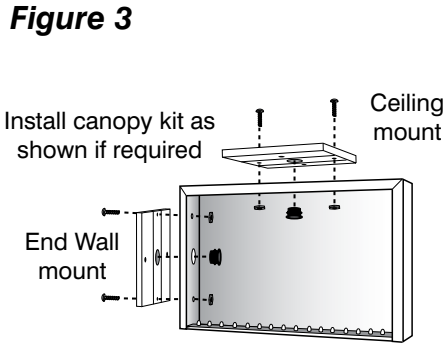
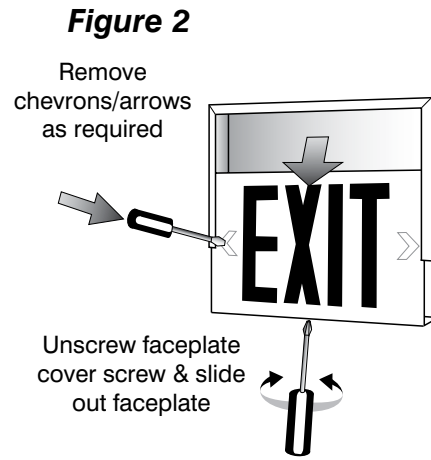
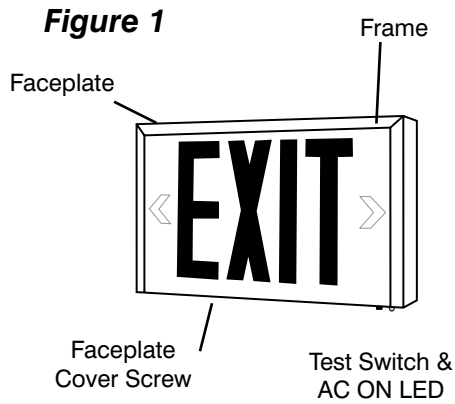

MAINTENANCE

1. Clean face(s) on a regular basis.

NOTE: The servicing of any parts should be performed by qualified service personnel only. The use of replacement parts not furnished by Beghelli USA, may cause equipment failure and will void the warranty.

SAVE THESE INSTRUCTIONS