

ILLUMINA®

LED | WET | IK05



LOGICA®

SANITATION

TITLE 20 TITLE 24



BS100LED

- The **ILLUMINA®** BS100LED is corrosion, flame and vandal resistant.
- **HOUSING:** 100% UV stabilized polycarbonate, liquid silicone perimeter gasket with memory retention.
- **DIFFUSER:** Frosted UV stabilized polycarbonate diffuser, providing even light distribution.
- **LUMENS:**

2FT	4FT
LO: 3876 to 4635 lm	VLO: 4375 to 5208 lm
MO: 5176 to 6172 lm	LO: 5555 to 6627 lm
HO: 6464 to 7716 lm	MO: 6944 to 8284 lm
	HO: 8318 to 9946 lm
	VHO: 9714 to 11,589 lm
- **OPERATING TEMP:** HT (AC Only) -40°F to 104°F (-40°C to 40°C)
SA (AC & Emergency) 32°F to 104°F (0°C to 40°C)
- **POWER FACTOR:** Power Factor > 0.95
- **TOTAL HARMONIC DISTORTION (THD):** < 20%
- **WEIGHT:** 4FT: 10 lbs. / 4.5 kg



APPLICATION: The **BS100LED** is ideal for various applications including retail, industrial, parking garages, carport, parking structures, warehouses, breezeways, canopies, schools, and much more. It can be installed both indoor and outdoor.

CONFIGURATIONS

MODEL	LENGTH	OPERATION	LUMENS	COLOR TEMP	INPUT	MOUNTING	OPTIONS
BS100LED	2 (ft)	HT (AC only)	VLO ²	WT30 (3000K)	120-277V	AC ³ (aviation cable)	BLK ⁸ (black housing)
	4 (ft)	SA ¹ (AC & EM)	LO	WT40 (4000K)	347-480V	CH ⁴ (chain hang kit)	WHT ⁸ (white housing)
			MO	WT50 (5000K)		DPK ⁴ (double pendant kit)	CRD ⁹ (blk, 18AWG, 3-conductor cord)
			HO			JM ⁵ (junction mount)	D (dali)
			VHO ²			MM ⁶ (magnet mount)	EOS ¹⁰ (external occupancy sensor)
						PM (pivot mount)	EOSL ¹¹ (external occ. sensor - LOGICA)
						QMB ⁷ (quick mount bracket)	FA ¹² (fully assembled)
						SPK ⁴ (single pendant kit)	FP (fuse protection - 3A)
						SVLDPK ⁴ (swivel double pendant kit)	IOSL ¹¹ (internal occ. sensor - LOGICA)
						SVLSPK ⁴ (swivel single pendant kit)	NODL ¹¹ (integrated node - LOGICA)
						TM ⁴ (trunion mount)	RLYL (wireless relay and sensor)
							SP (surge protection - 10KA)
							SS (stainless steel clips)
							TPS (tamper proof stainless steel screws)

NOTE 1: Title 20 emergency pack; 120/277V; 2FT: 7W/1022 lm, 4FT: 10W, 1573 lumens.

NOTE 2: VLO and VHO available for 4ft only.

NOTE 3: Specify length for AC: 50", 72", 100", 150", 250" fully adjustable.

NOTE 4: SPK, DPK, CH, TM, SVLSPK & SVLDPK options must specify length.

NOTE 5: JM option - the unit is no longer wet location, but damp location.

NOTE 6: Magnetic mounts must be installed to steel beam measuring minimum 3/16" (4.7mm) thick.

NOTE 7: QMB must be used with standard SM & JM.

NOTE 8: Contact factory. MOQ required.

NOTE 9: Specify length for CRD.

NOTE 10: Select CRMB 9, SBOR or PSP-221B family.

NOTE 11: Logica (Beghelli wireless and powerless control solutions). Contact factory for more details.

NOTE 12: Includes latches and grommets installed at the factory. Can be combined with the JM option.

NOTE: Surface mount is standard

TECHNICAL INFORMATION

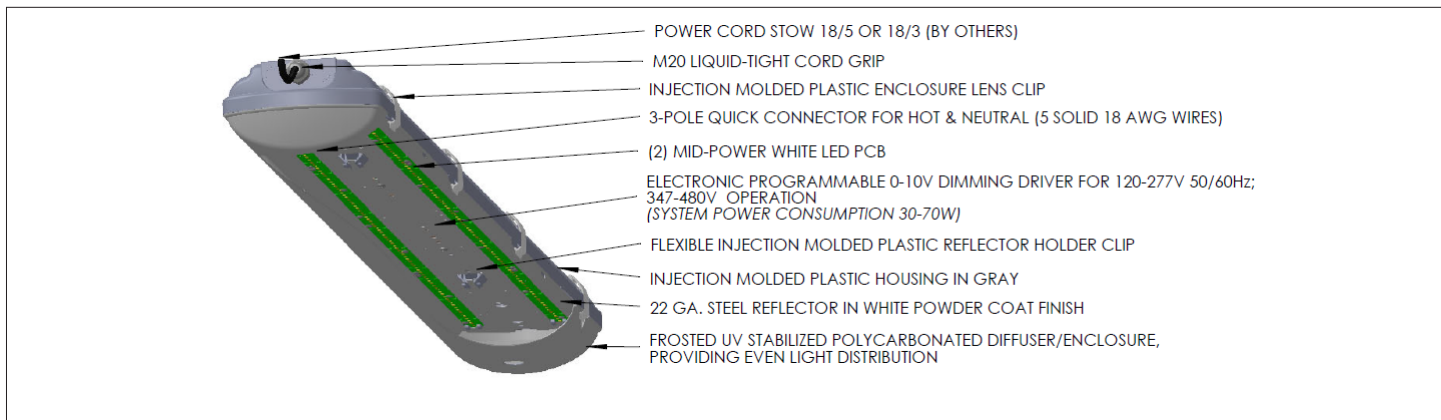

DIMENSIONS

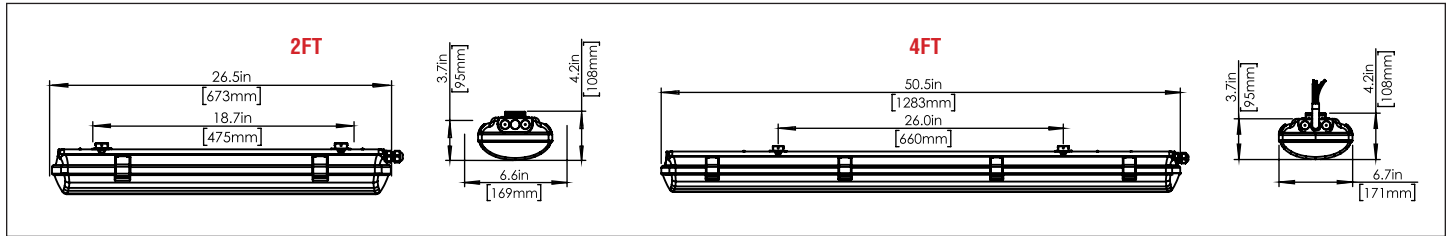

MOUNTING OPTIONS

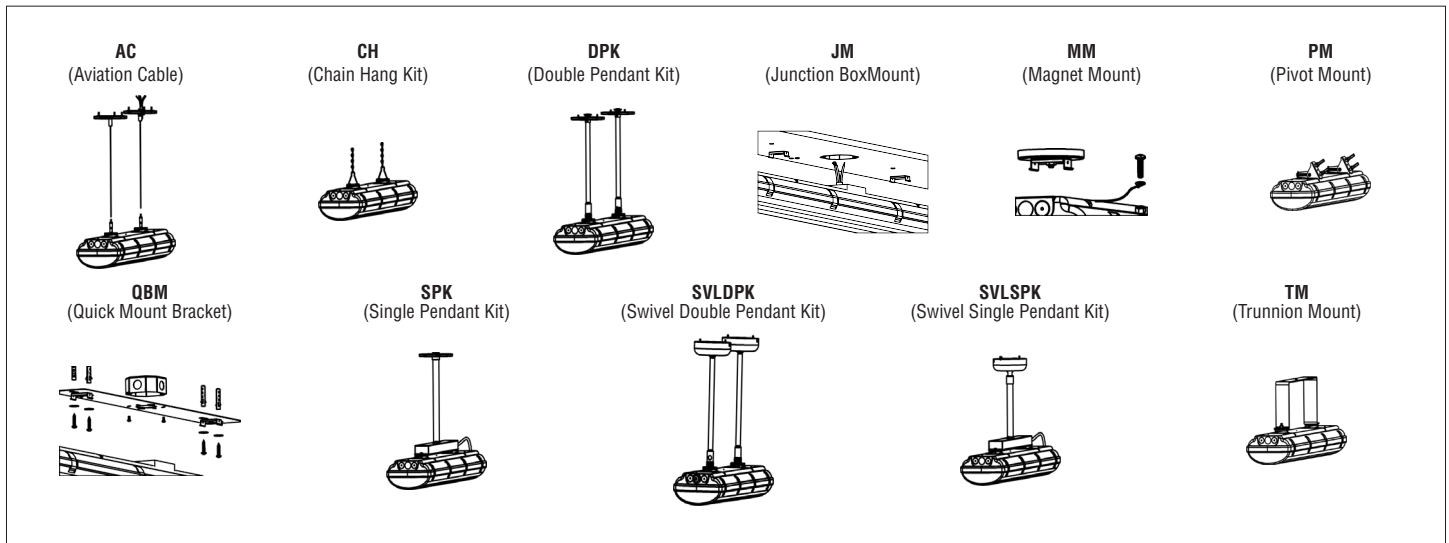

PHOTOMETRICS

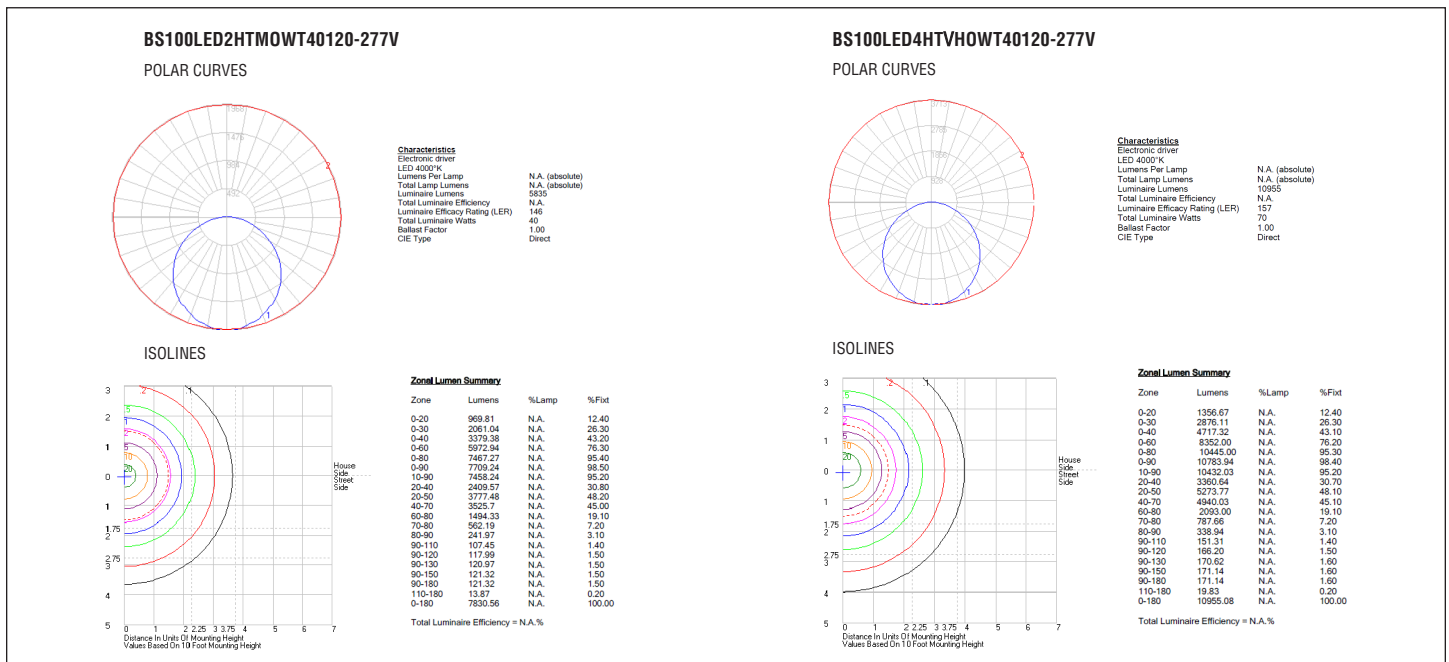

ILLUMINA® BS100LED

ADDITIONAL INFORMATION

ENERGY CHART

MODEL	LENGTH	EFFICACY	CONSUMPTION WATTAGE	LUMEN OUTPUT	CRI	L70 (HRS) TESTED	L70 (HRS) PROJECTED
2FT							
BS100LED-2HT-LO-WT30-120-277V	2 ft	129 lm/W	30	3876	>80	>60,000	>100,000
BS100LED-2HT-LO-WT40-120-277V	2 ft	146 lm/W	30	4381	>80	>60,000	>100,000
BS100LED-2HT-LO-WT50-120-277V	2 ft	154 lm/W	30	4635	>80	>60,000	>100,000
BS100LED-2HT-MO-WT30-120-277V	2 ft	129 lm/W	40	5176	>80	>60,000	>100,000
BS100LED-2HT-MO-WT40-120-277V	2 ft	146 lm/W	40	5835	>80	>60,000	>100,000
BS100LED-2HT-MO-WT50-120-277V	2 ft	154 lm/W	40	6172	>80	>60,000	>100,000
BS100LED-2HT-HO-WT30-120-277V	2 ft	129 lm/W	50	6464	>80	>60,000	>100,000
BS100LED-2HT-HO-WT40-120-277V	2 ft	146 lm/W	50	7301	>80	>60,000	>100,000
BS100LED-2HT-HO-WT50-120-277V	2 ft	154 lm/W	50	7716	>80	>60,000	>100,000
4FT							
BS100LED-4HT-VLO-WT30-120-277V	4 ft	146 lm/W	30	4375	>80	>60,000	>100,000
BS100LED-4HT-VLO-WT40-120-277V	4 ft	165 lm/W	30	4937	>80	>60,000	>100,000
BS100LED-4HT-VLO-WT50-120-277V	4 ft	174 lm/W	30	5208	>80	>60,000	>100,000
BS100LED-4HT-LO-WT30-120-277V	4 ft	139 lm/W	50	5555	>80	>60,000	>100,000
BS100LED-4HT-LO-WT40-120-277V	4 ft	157 lm/W	50	6264	>80	>60,000	>100,000
BS100LED-4HT-LO-WT50-120-277V	4 ft	166 lm/W	50	6627	>80	>60,000	>100,000
BS100LED-4HT-MO-WT30-120-277V	4 ft	139 lm/W	60	6944	>80	>60,000	>100,000
BS100LED-4HT-MO-WT40-120-277V	4 ft	157 lm/W	60	7831	>80	>60,000	>100,000
BS100LED-4HT-MO-WT50-120-277V	4 ft	166 lm/W	60	8284	>80	>60,000	>100,000
BS100LED-4HT-HO-WT35-120-277V	4 ft	139 lm/W	70	8318	>80	>60,000	>100,000
BS100LED-4HT-HO-WT40-120-277V	4 ft	157 lm/W	70	9400	>80	>60,000	>100,000
BS100LED-4HT-HO-WT50-120-277V	4 ft	166 lm/W	70	9946	>80	>60,000	>100,000
BS100LED-4HT-VHO-WT30-120-277V	4 ft	139 lm/W	70	9714	>80	>60,000	>100,000
BS100LED-4HT-VHO-WT40-120-277V	4 ft	157 lm/W	70	10955	>80	>60,000	>100,000
BS100LED-4HT-VHO-WT50-120-277V	4 ft	166 lm/W	70	11589	>80	>60,000	>100,000









ELECTRICAL RATING

PRODUCT	NOMINAL POWER (W)	AC CURRENT (A)		FREQUENCY (HZ)	DC VOLTAGE (V)	DC CURRENT (MA)
		120 V	277 V			
2FT						
BS100LED-2HT-LO	30	0.26	0.11	50/60	45	600
BS100LED-2HT-MO	40	0.34	0.15	50/60	45	800
BS100LED-2HT-HO	50	0.43	0.18	50/60	45	1000
4FT						
BS100LED-4HT-VLO	30	0.26	0.11	50/60	45	600
BS100LED-4HT-LO	40	0.34	0.15	50/60	45	800
BS100LED-4HT-MO	50	0.43	0.18	50/60	45	1000
BS100LED-4HT-HO	60	0.51	0.22	50/60	45	1200
BS100LED-4HT-VHO	70	0.59	0.26	50/60	45	1400

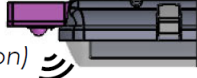
DIMMER COMPATIBILITY

DIMMER	COMPATABILITY	
	ON/OFF	DIMMING
2FT		
LEVITON - AWRMG-7	YES	YES
LUTRON - DIVE - DVSTV	YES	YES
LUTRON - DIVE - DVTV	YES	YES
WATT STOPPER - DCLV1	YES	YES
4FT		
LEVITON - AWRMG-7	YES	YES
LUTRON - DIVE - DVSTV	YES	YES
LUTRON - DIVE - DVTV	YES	YES
WATT STOPPER - DCLV1	YES	YES

LOGICA (WIRELESS & POWERLESS LIGHTING CONTROL SOLUTIONS)

DAISY CHAIN FIXTURES (RLYL)				EXTERNAL NODE & SENSOR (EOSL)		
<p>RLYL</p> <p>LOG-RLYL WIRELESS RELAY (DAMP LOCATION)</p> 	<p>LOG-ML2L REMOTE SENSOR (DAMP LOCATION)</p> 	<p>LOG-ESRPL SWITCH (ACCESSORY) (DAMP LOCATION)</p> 		<p>EOSL</p> <p>LOG-HBKO10VL/HBKODL NODE & SENSOR (EXTERNAL)</p>  <p>(wet location)</p>	<p>LOG-ESRPL SWITCH (ACCESSORY) (WET LOCATION)</p> 	
<p>CONTINUOUS ROW MOUNT ~ 63 FEET MAX. (wet location) (wiring by others base on 18AWG- 13 fixtures max.)</p>						
INTEGRATED NODE (NODL)			INTEGRATED NODE & SENSOR (IOSL)			
<p>NODL</p> <p>LOG-10V12L/DRDL (NODE 0-10V/DALI) (INTERNAL)</p>  <p>NODE (wet location)</p>	<p>LOG-ML2L REMOTE SENSOR (DAMP LOCATION)</p> 	<p>LOG-ESRPL SWITCH (ACCESSORY) (DAMP LOCATION)</p> 	<p>IOSL</p> <p>LOG-ML10VL/MLDL NODE & SENSOR (INTERNAL)</p> <p>(ON LENS) (wet location)</p> 	<p>LOG-ESRPL SWITCH (ACCESSORY) (DAMP LOCATION)</p> 		

NOTE: WHEN WALL MOUNTING, DAMP LOCATION ONLY.

■ **WARRANTY:** 5 years, see website for full warranty details.